

Finished Frame Dimensions

ABC's "Easy Sheet" series on building extruded aluminum sign frames - 8/03

15

ACCESS FRAMES

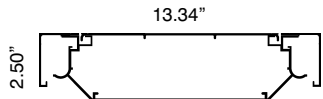

Large A/Flexframe - Flat Retainer

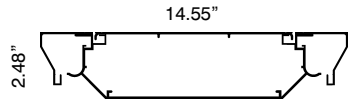

Large A/Flexframe - Beveled Retainer

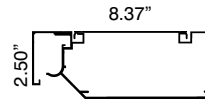

Small A/Flexframe - Flat Retainer

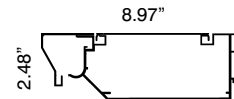

Small A/Flexframe - Beveled Retainer

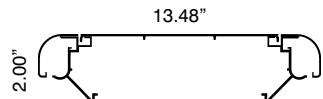

Large A/Flexframe - Radius Retainer

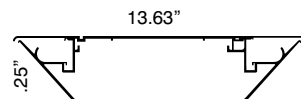

Large A/BleedFrame

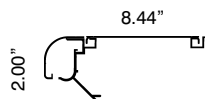

Small A/Flexframe - Radius Retainer

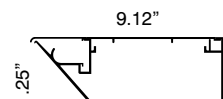

Small A/BleedFrame

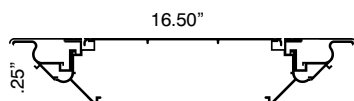

Large A/Flexframe with Bleed-Face Saddle



Small A/Flexframe with Bleed-Face Saddle

HINGE FRAMES

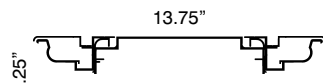

Double-Hinge Frame - Bleed Trim

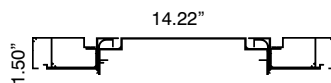

Double-Hinge Frame - Reveal Trim

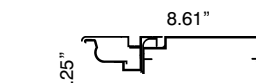

Single-Hinge Frame - Bleed Trim

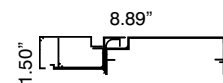

Single-Hinge Frame - Reveal Trim

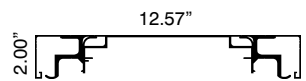

Double-Hinge Frame - HD R Saddle

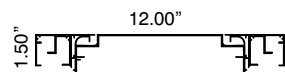

Double-Hinge Frame - Outside R

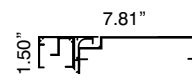

Single-Hinge Frame - Outside R

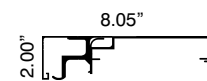

Single-Hinge Frame - HD R Saddle

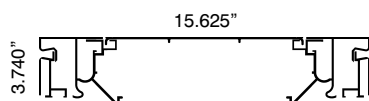

Heavy Duty Zero Clearance Hinge Frame with Large A/Flexframe

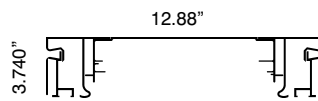

Heavy Duty Zero Clearance Hinge Frame with Type I Frame

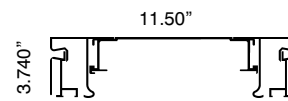

Heavy Duty Zero Clearance Hinge Frame with Type II Frame

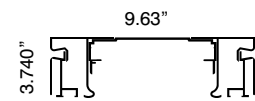

Heavy Duty Zero Clearance Hinge Frame with Type III Frame

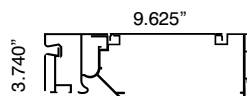

Heavy Duty Zero Clearance Hinge Frame with Small A/Flexframe

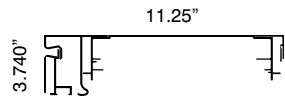

Heavy Duty Zero Clearance, Type I Frame and Back Adapter

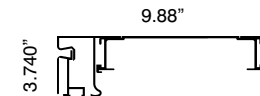

Heavy Duty Zero Clearance, Type II Frame and Back Adapter

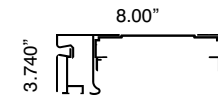

Heavy Duty Zero Clearance, Type III Frame and Back Adapter

ARCHITECTURAL FRAME COMPONENTS

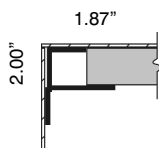

Square Edge Frame

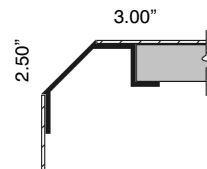

Bevel Edge Frame

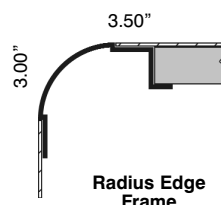

Radius Edge Frame

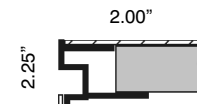

Insert Edge Frame

Please contact ABC if you have any questions:

2028 SE Frontage Road, Fort Collins, Colorado 80525

Toll-Free: 800-248-9889 Fax: 970-482-4019 Email: abcsigns@abcsignproducts.com

The parts described on this page are covered by one or more of the following patents:

U.S.	4,007,552	4,265,039			
CANADIAN	1,021,565	1,149,159	1,170,048	1,170,049	1,170,050



Finished Frame Dimensions (cont.)

ABC's "Easy Sheet" series on building extruded aluminum sign frames - 8/03

CONVENTIONAL FRAMES

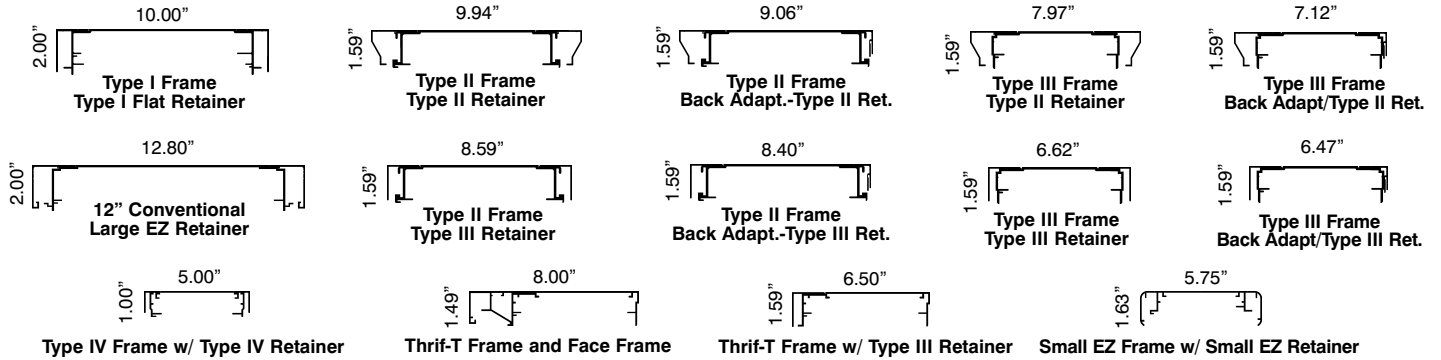

WIDE-FAB FRAMES

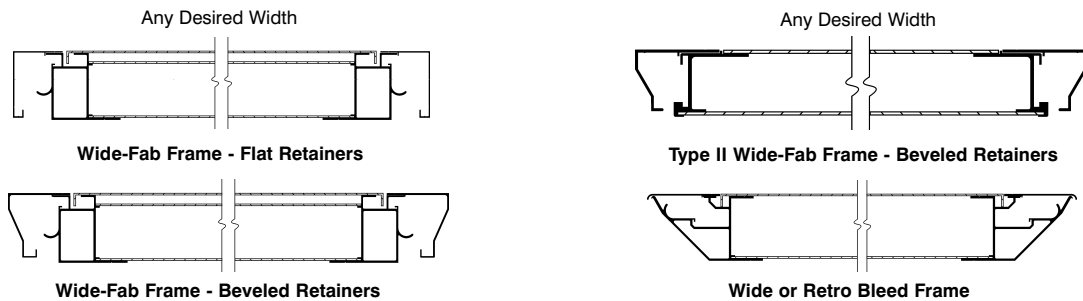

RETRO FRAMES

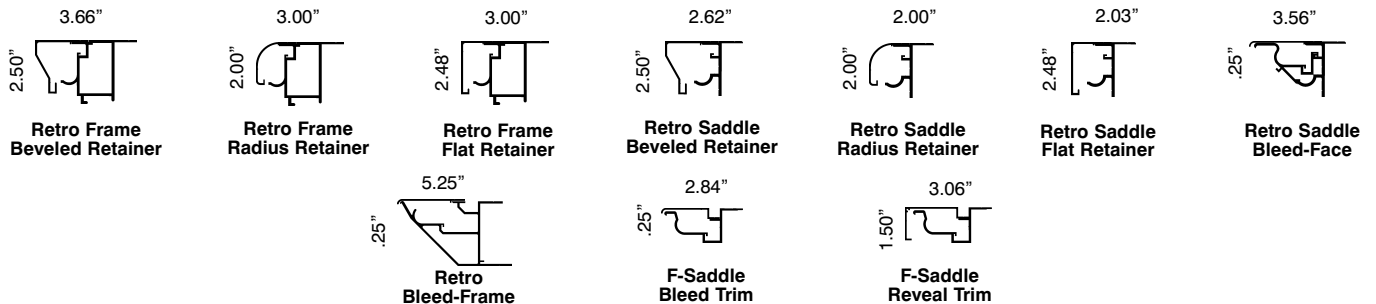

POST AND PANEL COMPONENTS

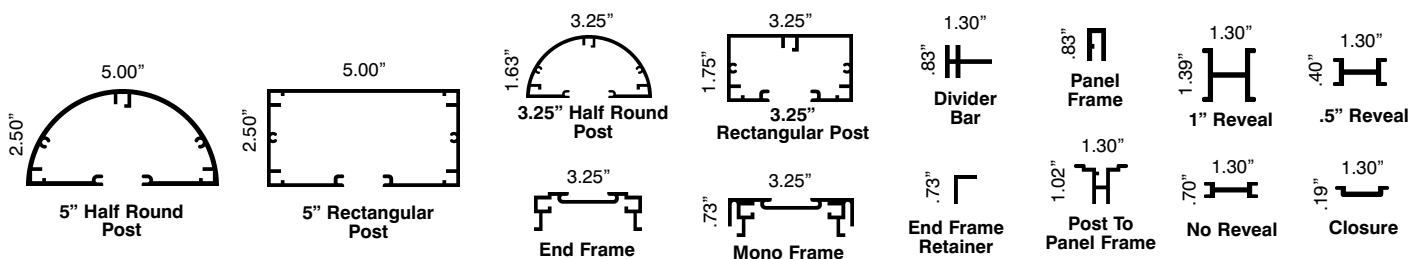

Please contact ABC if you have any questions:
 2028 SE Frontage Road, Fort Collins, Colorado 80525
 Toll-Free: 800-248-9889 Fax: 970-482-4019 Email: abcsignproducts.com

The parts described on this page are covered by one or more of the following patents:
 U.S. 4,007,552 4,265,039
 CANADIAN 1,021,565 1,149,159 1,170,048 1,170,049 1,170,050

